

HS 6613 ER-2
UNITED DOCTORS HOSPITAL
2530290-090-01

TABLE OF CONTENTS

PREFACE	1
SAFETY	3
Attention symbols	3
Reporting an accident or incident	5
INTRODUCTION	7
HS 66	7
Overview of safety devices	9
Built-in electrical steam generator	11
THE PROCESS	15
The steam sterilizing process	15
Maintenance program	17
Documentation of the process	17
Documentation of the process	20
INSTRUMENTS	23
OPERATION	25
Program start	25
Alarms - Avanti	26
Error codes	31
General advice when using the sterilizer	34
Weekly cleaning - Avanti	35
Approved consumables	37
OPERATION INSTRUCTIONS	43
Use	43
Daily preparations	44
CONTROL UNIT PACS 3500	49
Control panel type Avanti	51
Operator menu Avanti	60
PROGRAM COMBINATION	67

PREFACE

This USER MANUAL, contains all the information you need in order to safely operate your GETINGE STERILIZATION AB equipment.

Please read and follow the entire manual carefully, and please pay special attention to the framed warnings and caution remarks. See **“Attention symbols”** under **SAFETY**

In the event of an accident or incident you are obliged to report this. See **“Reporting an accident or incident”** under **SAFETY**

GETINGE STERILIZATION AB shall not be liable for any damages, directly or indirectly, due to actions, which are not in accordance with this manual.

By following this manual you are ensured quality equipment for many years ahead. Should any unforeseen problems occur, you are of course welcome to contact our local representative.

Manufacturer address:

Getinge Sterilization AB

Ekebergsvägen 26

305 75 Getinge

Sweden

Fax +46(0) 35 54952

SAFETY

Attention symbols

Some of the warnings, instructions and advice in this manual are so important that we use the following special symbols to draw attention to them. The designs and symbols used are:

Warnings



This symbol indicates a warning in the text of the manual. It warns of a hazard that may lead to more or less severe injury and in certain cases mortal danger.

The symbol is also used to highlight safety components, etc. See “Safety devices - an overview” in the *Introduction* chapter in the USER MANUAL or in the *Maintenance* chapter in the TECHNICAL MANUAL.

Instructions



This symbol highlights instructions that are important for avoiding damage to the unit and/or load, among other things.

Advice



This symbol indicates important advice and hints that make it easier to work with the unit.

Symbols on the unit

Hot surface

This symbol warns of a hot surface.



Electrical danger

This symbol warns of an electrical danger.



Other dangers

This symbol warns of other dangers.



Reporting an accident or incident



Use this information when reporting incidents and accidents involving the unit.

If an accident or an incident associated with the sterilizers occurs, this must be reported immediately in writing to the address below. The report must be used to identify the cause of the accident or incident and to what extent the occurrence was due to the unit

The unit is a product in the GETINGE range.

The unit may also be a sterilizer that is a medical engineering product and which conforms to the EU medical devices directive, or which is constructed in a similar way to a medical device. Under the medical devices directive, the manufacturer must investigate the cause of accidents/incidents that occur and report them to the authorities concerned.

The investigation may lead to changes in new or already delivered devices or in instructions and guidance.

The following circumstances must be reported:

1. Circumstances that caused the death of a patient, user or someone else, or that caused serious deterioration in the health of a patient, user or someone else.
2. Circumstances that might have caused, the death of a patient, user or someone else, or that might have caused serious deterioration in the health of a patient, user or someone else.

The following information is required:

The manufacturing number of the unit (on a label in the electrical cabinet), Date/time of event, Description of event, Consequences of event.

Contact: Name, Phone number, Address:, E-mail:

The information must be sent by letter or fax to:

GETINGE STERILIZATION AB

For the attention of: Quality Manager

Box 69

305 05 GETINGE

Sweden

Fax: +46 (0)35 549 52

INTRODUCTION

HS 66

HS 66 is the designation of a series of GETINGE high-pressure autoclaves with vertically sliding automatic doors, all with the door opening 660 x 660 mm

There are both stand-alone and built-in versions.

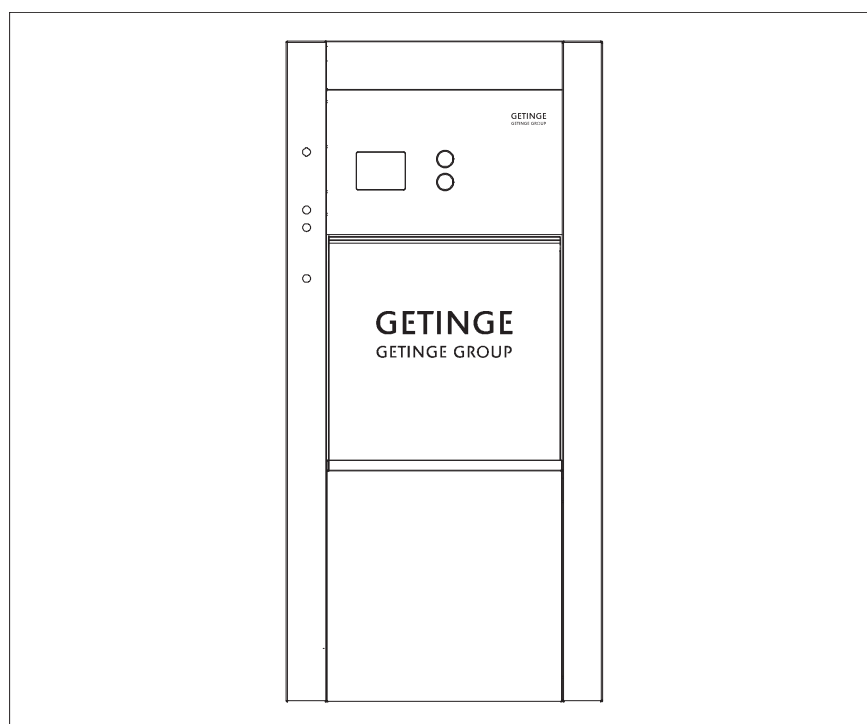

The autoclaves are intended for sterilization of materials in the health service as well as in industry. They are adapted to their particular functions by the choice of control equipment. This is built up around a microprocessor and therefore provides a very large number of process types, all characterized by exceptional accuracy in controlling the process parameters. The operator can call up on a display information on the current process, current process phase and the actual values of the parameters while the process is in progress.

The dominant sterilizing agent is steam at a temperature of 121 -134 °C. Material that is damaged by this temperature may be sterilized in some autoclave models in formalin vapour at 55 - 80°C.

Most types of items can be treated in the HS 66-autoclaves, using adapted programs:

Instruments, machine parts, glass, plastic, leather, textiles, hot or cold liquids in open or vented containers and small rigid pressure-tight containers filled with liquids.

European standard EN 285 (Australia/New Zealand, Standard AS 1410) specifies the use of fixed programs only. However, the control equipment of HS 66-autoclaves allows the programs to be made variable during the time testing is in progress.

As not only the processes but door operation too are controlled automatically, the step to full automation of the handling of sterile items is not a long one. The control unit is therefore prepared for controlling an autoclave having a GETINGE ASF automatic loading and unloading unit.

As with other GETINGE double-jacketed autoclaves, the external surface of the chamber is more than half covered by all-welded U-sections.. These stiffen the flat walls of the pressure vessel, and at the same time accommodate the steam which keeps the chamber walls warm in order to minimize condensation in the chamber. The design principle makes all welds accessible for visual inspection after the thermal insulation has been removed.

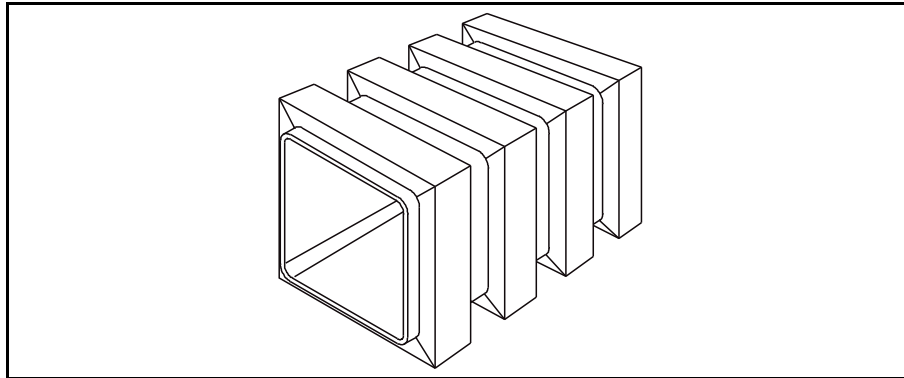

A vacuum pump of the water-ring type removes air, steam and condensation from the chamber and door-gasket groove. The sealing water of the pump is taken from an open tank which in some cases also supplies the feedwater pump, on autoclaves with a steam generator, with water.

The condenser between the chamber and vacuum pump converts waste steam to water. This reduction of the pump handling volume contributes greatly to improving pump efficiency and protecting the pump and waste pipes against high temperatures.

A well-damped discharge system after the vacuum pump and well-dimensioned thermal insulation around the chamber mean that the autoclave affects the surroundings to an insignificant extent and is therefore easy to position.

HS 66-autoclaves have to be supplied with electricity, cold water, compressed air and steam. When steam is supplied from a central steam-producing plant, its distribution system is required to be correctly pressure-reduced, protected by a safety valve and produce a quality of steam which is suitable in the context of sterilization. (For some versions the pressure reducer is already fitted)

If the steam is not suitable in the context of sterilization, a steam generator can be installed inside the trim plates on all models. The task of the

steam generator is to generate pure steam using the centrally produced steam.

If there is no steam network or there are reasons for not using the steam network, an electric steam generator may be installed inside the trim plates on all models.

Overview of safety devices



Cladding and front panels must prevent access to the parts of the installation that are normally accessible only to trained personnel.

General access to an installation supplied without cladding, which should normally only be maintained by trained personnel must be prevented. A convenient way of preventing access is to install the equipment in a lockable area.

Additional information about the above safety components are given in the “Safety checks”, “Utility data” and “Periodic maintenance” sections of the TECHNICAL MANUAL.

Safety components

Every unit is equipped with a number of components with the specific purpose of ensuring the safety of personnel. These items are marked with a warning triangle below in the following documents:

- **electrical diagrams**
- **pipework diagrams**
- **spare parts lists**



These components have undergone special tests before being accepted as safety components. For this reason, they must not be replaced with components of any make or design that has not been approved by GETINGE.

It is of the highest importance that the operational reliability of these components is continuously upheld during their entire service life.

The signs are used not only to indicate important components, but also to draw attention to other safety factors that call for special attention, such as dimensions, tolerances, materials, etc.

Doors

The doors are closed and locked while the process is running and remain locked in the event of media loss. The doors cannot be opened until the pressure in the chamber has been equalized with the ambient pressure, not even if fault management gives an opening command. The sliding doors are operated by a compressed air cylinder which has a severely throttled inlet. A drain valve with a considerably greater flow capacity than the inlet is located in the bottom of the cylinder, which is pointing upwards. Objects that obstruct the upward motion of the door press down a metal plate which opens the drain valve, causing the door motion to stop. This prevents operator injuries and material damage. A support latch holds the door so that it does not open if the pneumatic operating cylinder loses pressure. When the pressure of the compressed air is so low that the door cylinder cannot support the weight of the door, the air is not capable of pulling away the support latch.

Emergency stop

In the front panel, at the side of the door, there is a pushbutton with these functions:

- A **On door operation.**
to stop the door motion immediately during door operation. Pressing the button triggers an alarm. This alarm stops the door immediately:
- B **When the door is closed**
The current process is aborted and all valves for media to the chamber are closed. This also triggers an alarm.

Door interlock key

The front panel contains a key switch, intended for use when cleaning the sterilizer or when it is necessary to reach into the chamber for any reason.

With the key removed, the door cannot be closed. See also under "Cleaning the chamber" in the *Operation* chapter.

Trim plates

Panels are possible to dismount by means of tools or keys. The panels form a barrier for operators, but not for specially trained technicians. Stainless steel surfaces within reach of the operating personnel are insulated and cooled to a harmless temperature.

Valves

If the equipment has electrically and/or pneumatically actuated valves they are normally made to close by means of spring force. This prevents

undesired flow through the valves in case of power failure. A fail safe function is achieved.

Pressure vessels

The sterilizer chamber jacket and steam generator are pressure vessels, designed and built in accordance with standards laid down by official bodies charged with monitoring this area of safety.

The internal steam supply to the sterilizer is protected against excessive supply pressure by a safety on the steam generator, the sterilizer or both.

The connected supply lines from external steam, water or compressed air networks must be protected against excessive pressure by safety valves. The sterilizer supplier is not responsible for these valves. Permitted supply media pressures are stated in "Utility data".

Safety valves

Safety valves limit the system pressure, providing the last line of protection to prevent the design pressure of the vessel from being exceeded. Safety valves are required to be inspected at prescribed intervals.

Monitoring the pressure behind the door seal

All valves admitting any medium to the chamber are kept closed until the pressure behind the door seal is high enough to guarantee the tightness of the chamber.

Built-in electrical steam generator

The sterilizer also has a fully-automatic built-in steam generator, with tubular electric elements as the heat source.

Operation

The heating power is divided among a number of groups of elements. The elements are controlled by a pressure switch with double changeover contacts, one for each heater element circuit. One group of contacts limits the operating pressure of the steam generator. The other controls reconnection of the power when the minimum pressure is reached.

Pressures higher than those stated on the electrical diagram should not be set, since the steam will be superheated when admitted to the sterilizer chamber. On the other hand, if the operating pressure is allowed to fall too far, the steam tends to become wet, which is undesirable for sterilisation purposes.

A feedwater pump supplies the steam generator with water from an integral water tank with air trap. The water level of the steam generator is sensed by a device which controls the operation of the pump so that the level is kept almost constant. Boil-dry protection cuts off the supply of electric power to the elements when the water level is low.

See also “Steam generator settings and controls” under *Advice and instructions* in the TECHNICAL MANUAL.

Control switch

The steam generator and sterilizer are controlled by the same switch. On sterilizers with med double steam systems there is an extra shutoff button marked *Steam generator*.

Pressure regulation in power stages

The system prevents wear of the element contacts by switching the power in and out in two stages at different pressure levels and with a time offset between switch-on and switch-off for the first stage.

Spark-reduction connection

As well as shortening the life of electrical contacts, sparking at the contacts may also cause interference with nearby electronic equipment. The anti-spark protection is based on fast-acting auxiliary relays taking over the load from the slow-breaking contacts of the pressure switch for operating pressure, so largely eliminated sparking.

Safety valve, steam generator

The mandatory periodic check of the operation of the steam generator safety valve can be done simply by means of the keyswitch described below. See also the *Maintenance* chapter in the TECHNICAL MANUAL.

Keyswitch “Test pressure limiter”

When the key is in the safety valve check position, steam is produced continuously and regardless of the setting of the operating pressure switch.

Water level regulation

Version with conductive measurement

The Getinge conductive level system is designed for water with a conductivity above 2 $\mu\text{S}/\text{cm}$.

The task of the level device is to sense and control the water level of the steam generator. The main components are a sensitive relay and two electrodes, the ends of which touch the water surface at the upper and lower fill levels. Contact of the upper electrode with the water stops the feedwater pump, whilst absence of contact at the lower electrode starts the pump. A third, lowest, electrode cuts off the electric power supply to the heating elements when the electrode loses contact with water; see boil-dry protection below.

The type and sensitivity of the level relays can be adapted to varying water conductivity. If the feedwater is de-ionised, a high-sensitivity level relay is required and the sensitivity setting must be increased as the conductivity of the water decreases.

The sensitivity of the level relay is automatically adjusted at power up to match varying conductivity.

The distance between the electrodes is another factor that affects the overall sensitivity of the level control system.

Version with float

The GETINGE float-based level control system is intended for water with a conductivity of 0 to 2 $\mu\text{S}/\text{cm}$, but it can also be used for higher conductivity.

The task of the level device is to sense and control the water level in the steam generator. The main components are a float with two level contacts and two relays. The level contacts change over at the upper and lower fill levels. The upper contact stops and starts the feedwater pump, whilst the lower contact cuts off the electric power supply to the heating elements; see boil-dry protection below. The purpose of the relays is to protect the float contacts from harmful currents.

Water-level monitoring

A lamp in the “reset level” button on the steam generator control panel is lit when the water level is correct. On some models, the water level can also be read off on a sight glass. The sight glass has two valves which can be closed to prevent loss of water and steam in the event of breakage of the sight glass.

Boil-dry protection

If the water filling fails, the boil-dry protection cuts off the electric power supply after a certain time, when the water level has fallen below a minimum limit.

Overheat protection

This protection prevents the steam generator from overheating if the boil-dry protection should fail to operate.

Overfilling protection

The timer relay prevents the steam generator over-filling with feedwater if the level control system stops working.

“Reset level” button

If a fault occurs on any of the safety components of the steam generator, it must be reset manually in accordance with applicable boiler regulations.

The button is also used when filling an empty steam generator with water. See the *Function check* chapter in the INSTALLATION MANUAL.

“Test level limiter” button

This button provides a quick test of the operation of the boil-dry protection. The test interrupts the level circuit without the need to reduce the water level.

RCD

Some types of steam generator must be connected to the electric power supply via a residual current device (RCD). See the *Installation instructions* chapter in the INSTALLATION MANUAL.

Safety switch

It must be possible to isolate all electric power supplies to the steam generator with a safety switch. The safety switch must be lockable in the OFF position. See also chapter *Installation* in the INSTALLATION MANUAL.

THE PROCESS

The steam sterilizing process

The universal steam autoclaving process can be divided into three main phases:

- A Pre-treatment**
- B Sterilizing**
- C Post-treatment**

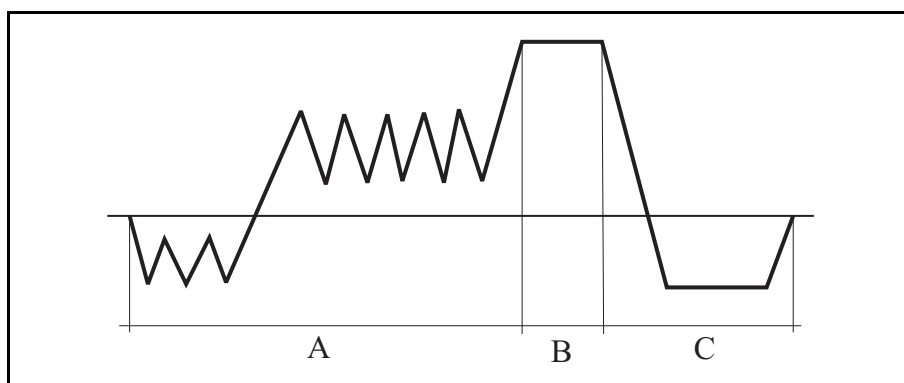

Pre-treatment

It has been found that moisture is an essential element in achieving sterility with steam. It is therefore important that the steam comes into close contact with the micro-organisms to be killed.

A pre-treatment phase consisting of a number of pressure variations following a certain pattern effectively removes air from various types of goods and produces the moisture required in the subsequent sterilizing phase. Depending on the equipment of the sterilizer, steam may pass through before the evacuations.

Air removal when autoclaving liquids in open containers is by applying a vacuum or by flowing steam, to ensure that the liquid does not boil during the decompression periods in a pulsating procedure.

Sterilizing

For sterilizers equipped with a computerized control unit, the sterilizing time starts at the instant in the pre-treatment phase of the process when the chamber temperature sensor signals a temperature equal to or higher than the sterilizing temperature specified for the current program. An alarm sounds if the temperature sensor registers a value outside the temperature band, or if the temperature differs by more than the permitted amount from the chosen sterilizing temperature.

When sterilizing liquids, the temperature is measured with a temperature sensor in the load. The condition for countdown of sterilizing time is that both temperature sensors in the chamber and the sensor in the load indicate the programmed sterilizing temperature.

Post-treatment

The purpose of the post-treatment is to normalize the temperature and moisture content of the goods. All goods except liquids are therefore exposed for a certain time to a vacuum below 70 mbar (a). After such post-treatment, textiles may appear to increase in weight by about 1%. This represents the normal addition of water that occurs during steam autoclaving process.

Post-treatment of liquids that have been sterilized in open or half-closed containers consists of a self-cooling period. During this period the pressure and temperature are lowered very slowly until the temperature is well below the boiling point of the liquid. This process is speeded up by applying a slight vacuum to the chamber when its pressure approaches atmospheric.



NOTE: Liquids must only be processed in sterilizers which have a program for this type of load.

Pressure equalization from vacuum takes place by admitting atmospheric air into the chamber via a filter that prevents bacteria from entering the chamber. The efficiency of the filter is 99.998% for particles of the order of 0.3 micron (0.0003 mm) in size.

The sterilizer door is kept closed by the door gasket until the pressure in the chamber is equal to atmospheric pressure.

Process adaptation

A large number of factors such as type of goods, goods carrier, packaging material, etc. affect the result of the process. The control equipment offers a number of features that can be used to optimize the processes to suit the requirements of different customers. For further information, see "User-programmable functions" in the TECHNICAL MANUAL.

Maintenance program

Leak test

Fully automatic process for steam autoclaves

With autoclaves equipped with an analogue pressure transducer the leak test can easily be automatically performed. The leak test is to be performed with an empty chamber. The chamber additionally has to have been warm, for example as a result of a heating program having been run beforehand.

The checking process has its own program button (see program list) which starts with the vacuum system evacuating the chamber. Depending on the equipment of the sterilizer, steam may pass through before the evacuation. The pump in the vacuum system stops when a deep vacuum has been created. For a short period of time after this evacuation a slight rise in the chamber pressure takes place which is not due to leakage but results from evaporation of condensate and temperature-volume changes in the recently rarefied residual steam.

It is therefore not possible to establish that an increase in pressure in the chamber is caused by leakage until conditions in the chamber have stabilized. It is not until about 10 minutes after the pump has stopped that the pressure and time start to be measured.

A satisfactory leak test allows for a maximum permissible pressure rise of 13 mbar / 10 minutes.

With double-ended autoclaves, the loading door opens after a completed leak test either automatically or manually, depending on how it has been programmed.

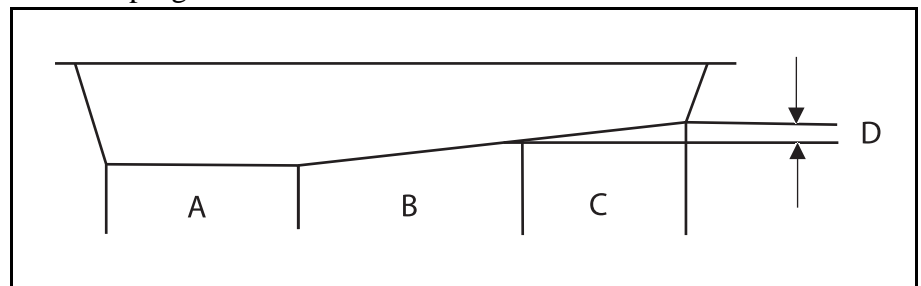

- A Normal vacuum 5 min.
- B Stabilization of chamber atmosphere 10 min.
- C Check time 10 min.
- D Pressure stepping max. 13 mbar.

Documentation of the process

A panel printer prints out data logged during the process.

See *Components* in the TECHNICAL MANUAL for printer settings and maintenance.

The system stores the last process so that an “emergency printout” can be produced afterwards if there is a problem with transmission of the printout or with the printer itself.

If the system is fitted with a SUPERVISOR, the printer is connected to that. Otherwise it is normally connected to the control system. SUPERVISOR is an independent measuring system that records the process data of the sterilizer. See also *Control unit* in the TECHNICAL MANUAL for further information.



The illustration below is schematic and must not be used as a template for evaluating individual process results.

13:47 29 06 04				
SIGNATURE				6
PROCESS OK				5
00:24:58	71.2	132.5	85.2	0.995
PROCESS COMPLETE				
00:23:39	75.5	132.5	85.2	0.039
EQUALIZATION				
00:18:35	51.1	132.2	88.6	0.096
00:16:14	134.9	135.4	134.8	3.076
DRYING				
HIGHEST TEMP		135.2C		
LOWEST TEMP		134.9C 134.9C		
00:16:08	135.0	135.5	134.9	3.094
4				
POST-TREATMENT				
00:12:07	134.1	134.3	134.0	3.039
STERILIZING				
00:09:10	106.5	132.6	103.6	1.088

HEATING					
00:08:50	115.8	132.5	115.6	1.880	
00:08:33	107.8	132.6	104.3	1.107	
POS PULSING					
00:08:14	115.9	132.5	115.7	1.876	
00:07:57	107.2	132.6	103.1	1.103	
POS PULSING					
00:07:38	116.0	132.6	115.7	1.880	
00:07:21	106.0	132.6	100.1	1.119	
POS PULSING					
00:07:02	116.1	132.2	114.9	1.877	
00:06:44	104.5	132.4	77.2	1.090	
POS PULSING					
00:06:24	116.6	132.3	87.4	1.875	
00:05:52	92.0	132.5	34.0	0.835	
POS PULSING					
00:05:32	78.4	132.7	33.7	0.065	
00:04:22	91.3	132.5	33.9	0.836	
NEG PULSING					
00:04:01	75.1	132.5	33.4	0.066	
00:02:54	81.4	132.5	33.7	0.849	4
NEG PULSING					
00:02:37	81.9	132.6	33.4	0.099	
00:00:15	46.6	132.6	33.4	0.997	
NEG PULSING					
00:00:00	46.5	132.5	33.4	0.997	
START					
PROG. TIME	AI00	AI01	AI02	AI03	
PROGRAM: P1 POROUS LOAD 134					
AI03	CHAMBER PRESSURE				
AI02	AIR DETECTOR				

AI01	JACKET TEMP	3
A100	DRAIN TEMP	
SIGNALS		
DRYING AIR PULSE	00:00:00	2
DRYING STEAM PULSE	00:00:00	
DRYING TIME	00:05:00	
STERILIZING TIME	00:04:00	
STER. TEMP.	134.0 C	
POS. PULSE	5	
NEG. PULSE	3	
PARAMETER SET- TINGS		1
CYCLE COUNTER	:16	
MACHINE NAME	:HS55	
PROCESS START	13:20:45	
DATE	29/06/2004	

1. The lower part shows the date and time when the process was started and the type designation, number and cycle counter of the sterilizer.
2. Above the heading “Parameter settings” there is a list of the parameters of the current program that can be changed with a parameter code. In this example, sterilizing temperature in °C and times for various sub-processes in hours, minutes and seconds.
3. Above the heading “Signals” there is a list of the parameters chosen for printing.
4. Information about which program has been started, followed by process logging.
5. Printed out if an error occurs during the process.
6. Signature line

Documentation of the process

An A4 printer prints out data logged during the process.

See *Components* in the TECHNICAL MANUAL for printer settings and maintenance.

Printout is possible in four modes. The mode shown below is preset before delivery and is recommended by GETINGE.

The system stores the last process so that an “emergency printout” can be produced afterwards if there is a problem with transmission of the printout or with the printer itself.

If the system is fitted with a PACS SUPERVISOR, the printer is connected to that. Otherwise it is normally connected to the control system. PACS SUPERVISOR is an independent measuring system that records the process data of the sterilizer. See also *Control unit* in the TECHNICAL MANUAL for further information.

 **The illustration below is schematic and must not be used as a template for evaluating individual process results.**

DATE 16/05/2001		SIGNALS		Page: 1			
PROCESS START 08:01:36		AI00	DRAIN TEMP				
AUTOCLAVE NAME HS6613-2		AI24	S DRAIN TEMP				
AUTOCLAVE NUMBER 1 1		AI03	CHAMBER PRESS.				
CYCLE COUNTER 5		AI27	S CHAMBER PRESS.				
		AI04	T1	3			
		AI05	TI2				
PARAMETERS 2							
NEG. PULSE 3							
POS. PULSE 5							
STERILIZING TEMP 134.0 C							
STERILIZING TIME 00:07:00							
DRYING TIME 00:05:00							
DRYING STEAMPULSE 00:00:00							
DRYING AIRPULSE 00:00:00							
PROGRAM: P1 POROUS LOAD 134							
PROGTIME	AI00	AI24	AI03	AI27	AI04	AI05	4
START							
00:00:01	83,1	82,7	1.000	1.021	89.2	89.1	
NEG. PULSE							
00:00:23	82.3	82.3	0.955	0.960	101.4	101.0	
00:02:53	67.4	67.4	0.100	0.097	105.6	104.1	
POS. PULSE							
00:00:03	93.4	93.3	0.822	0.822	120.6	120.8	
00:00:58	117.5	117.5	1.865	1.865	129.9	129.9	
HEAT UP							
00:00:49	104.5	104.5	1.245	1.251	113.5	113.7	
STERILIZING							
00:01:14	134.4	134.3	3.052	3.065	134.1	133.9	
00:03:14	135.0	135.0	3.116	3.120	135.3	135.4	
IDENTIFICATION: HS6613-2 1 CYCLE COUNTER: 5						Page: 2	
PROGTIME	AI00	AI24	AI03	AI27	AI04	AI05	4
00:00:14	135.0	135.0	3.116	3.116	135.2	135.3	
LOWEST TEMP		134.9					
DRYING							
00:00:18	135.0	135.0	3.110	3.113	135.2	135.3	
HIGHEST TEMP		135.2					
00:02:12	60.1	59.9	0.130	0.124	105.2	105.4	
EQUALIZATION							
00:03:16	89.9	89.8	0.055	0.052	119.6	119.2	
PROCESS COMPLETE							
00:33:27	93.7	93.6	0.987	0.987	130.3	130.1	
PROCESS FAILURE		5					
SIGNATURE: _____						6	
DATE	: 16/05/2001		PARAMETERS		Page: 3		

```

PROCESS START      : 08:01:36          NEG. PULSE       3
AUTOCLAVE NAME    : HS6613-2         POS. PULSE       5
AUTOCLAVE NUMBER  : 1                STERILIZING TEMP 134.0 C
CYCLE COUNTER     : 5                DRYING TIME      00:07:00
                                           DRYING TIME      00:05:00
                                           DRYING STEAMPULSE 00:00:00
                                           DRYING AIRPULSE 00:00:00

```

PROGRAM: P1 POROUS LOAD 134

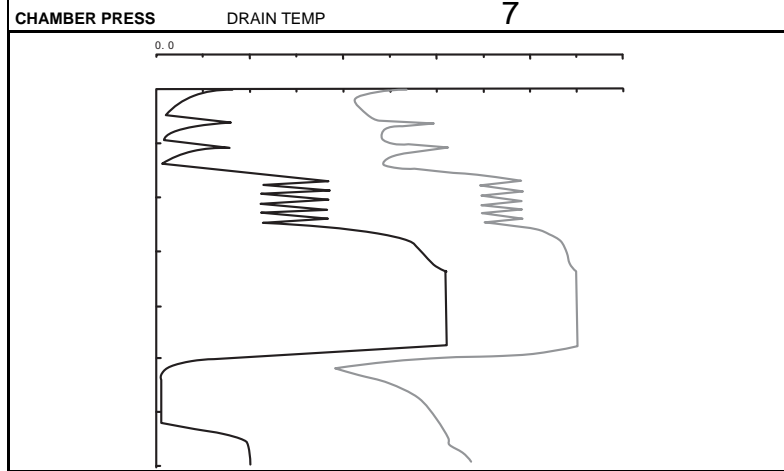

- 1 In the top part, the date and time when the process was started and the type designation, number and cycle counter of the sterilizer are shown.
- 2 Parameters of the current program that can be changed with a parameter code are listed under PARAMETERS. In this example, sterilizing temperature in °C and times for various sub-processes in hours, minutes and seconds.
- 3 The parameters chosen for printing are listed under SIGNALS.
- 4 Information about which program has been started, followed by process logging.
- 5 Printed out if an error occurs during the process.
- 6 These lines are printed out after a faulty process. Identification code of the person who entered the password and a line for a signature.
- 7 Graphical representation of the process

INSTRUMENTS

Loading side

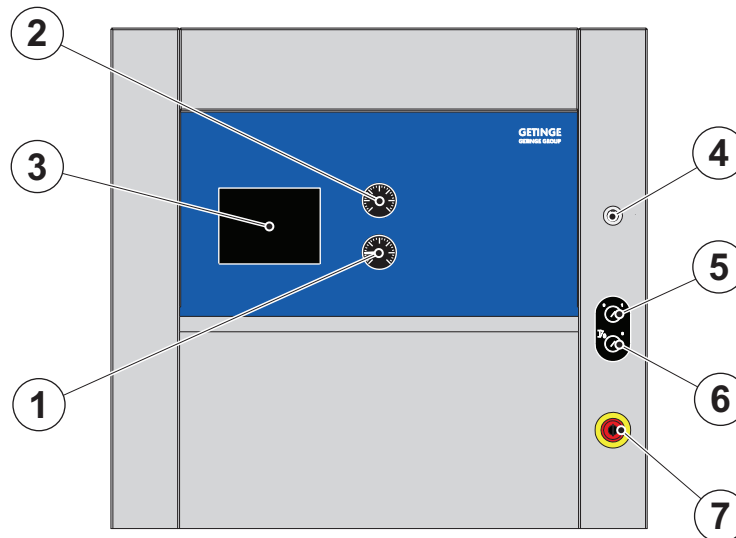

- | | |
|-------------------------------------|-----------------------|
| 1. Steam supply pressure gauge. | 5. Control switch. |
| 2. Pressure gauge chamber pressure. | 6. Door interlock key |
| 3. Operator's control panel | 7. Emergency stop. |
| 4. Panel lock. | |

Operator's control panel

Learn the function of the control panel by studying chapter *Control unit PACS 3500*.

Door-blocking key

See chapter *Introduction*, “Safety devices, an overview”.

Emergency stop

See chapter *Introduction*, “Safety devices, an overview”.

Unloading side

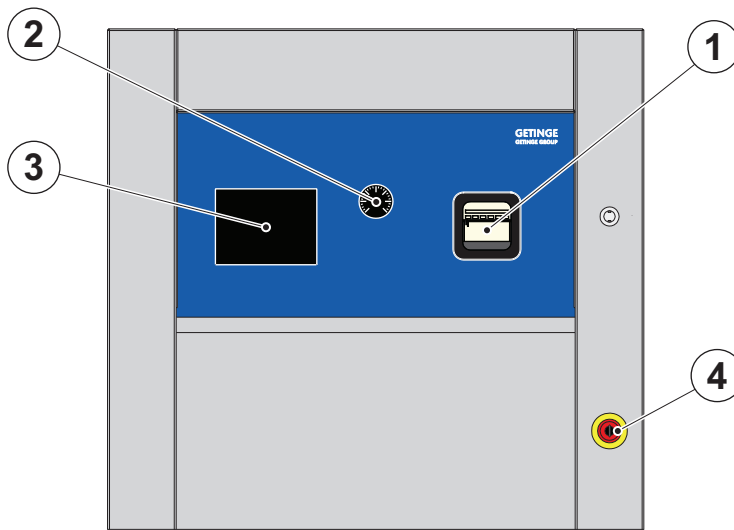

- | | |
|---|-----------------------------|
| 1. Recorder for temperature and pressure. | 3. Operator's control panel |
| 2. Pressure gauge chamber pressure. | 4. Emergency stop. |

Recorder

See recorder operating instructions in the **TECHNICAL MANUAL** chapter *Components*.

Operator's control panel

Learn the function of the control panel by studying chapter *Control unit PACS 3500*.

Emergency stop

See chapter *Introduction*, "Safety devices, an overview".

OPERATION

Program start

Where applicable, the operator must state process parameters and other information requested by the control system. On equipment where an authorisation code for programs not intended for routine sterilization is activated, the operator must also enter an authorisation code immediately after startup.

Via operator panel Avanti

To start a cycle:

- Select the desired cycle.
- Load goods and close the door.
- Wait until the Door closed indicator lights up and the **Start** button becomes visible. Now the machine is ready to start.
- Start the cycle.



Process startup is prevented if:

- there is an unacknowledged alarm
- the door is not closed and interlocked in accordance with the conditions
- the control system has detected an interlocking error (affects door safety)
- the keyswitch for manual stepping is activated
- the keyswitch for door blocking has been activated (only if there is a keyswitch)
- media supply, eg steam or cooling water, is not available (only if the sterilizer is equipped with sensors for this).
- the jacket temperature has not been reached or is too high (only if the process includes jacket heating)

Authorization protected programs only:

After the start button is pressed, the operator is [START] requested to enter the authorization code.

Message

If the operator chooses to attempt to start the sterilizer, even though starting is blocked, the operator panel display shows a message referring to an essential condition that is not met.

- JACKET TEMP HIGH - Indicates that lowering of jacket temperature is in progress.
- JACKET TEMP LOW - Indicates that raising of jacket temperature is in progress.
- STEPPING KEY ON - Indicates that key switch for stepping is on.
- PRINTING ACTIVE - Indicates that printing from the printer is blocking the start of a new program.
- UNACKNOWLEDGED ALARM – Indicates that a previous alarm has not been acknowledged and blocks the start of a new program.
- SEAL PRESSURE – Indicates that the door seal is pressurised.
- DOOR KEYSWITCH - Indicates that the keyswitch for cleaning is on.
- DOOR NOT CLOSED - Indicates that a sterilizer door is not properly closed.
- LOW WATER LEVEL – Indicates that the water level in the tank is low.
- COMPRESSED AIR – Indicates that the pressure of the air supply is low.
- DEGASSING TANK – Indicates that the temperature in the degassing tank is low.
- START CONDITION - Indicates that a starting condition specific to the type of unit is not met.
(Steam, cooling water, formalin bottle or ventilation at formalin sterilizers)

Alarms - Avanti

If a fault occurs, in standby or during a cycle, the system goes to an alarm phase. This is an exceptional situation, but it is normally not dangerous. The current cycle is stopped and output signals from the control system go to settings that maintain the safety of personnel, the unit, and the load.

- An alarm signal goes off and the relevant fault code is displayed on the cycle screen, while the cycle screen's background turns red.
- After the alarm signal goes silent, the Alarm indicator in the status field blinks.
- If the unit is equipped with a printer, the alarm text is also printed out as part of the cycle log.



**In case of alarm:
Read the error message and correct the fault.**

The fault codes are explained later in this chapter.



In case of an error concerning a temperature sensor, a pressure transducer or the Back-up battery a service technician is to be called for.

Blowing safety valve

If a safety valve blows off:

- Press the EMERGENCY STOP button.
- If this has no effect, cut off the electric power supply with the control switch on the front of the unit.
- In an emergency, the power supply can be cut off with the working switch.

Send for a service technician without delay.



On power failure or if the control switch or working switch of the sterilizer had to be turned off during a process, there is a risk of leakage at the door. Safety measure when there is positive pressure in the chamber:

KEEP WELL AWAY FROM THE DOOR AND CALL A TECHNICIAN!

Alarms in standby mode

An alarm from an idle sterilizer prevents it being started.

- Call a technician.



If the load contains liquids, choosing the wrong program may endanger personnel and equipment.

Alarms during a cycle / Avanti

A fault occurring during a cycle stops the cycle. All valves close in order to stabilize the conditions in the chamber.

An alarm signal sounds and the relevant error code is displayed on the cycle screen. The cycle screen's background turns red and the Alarm indicator is shown.



- Press **Silent alarm signal** to turn off the alarm signal.



- To show detailed alarm information press **Alarm**. The most recent alarm is displayed at the top of the list. Press the desired alarm to get detailed information about the alarm.



- After acknowledging the alarm, the following alternatives are available:
 - Automatic quick stop of the cycle
 - Call a technician.

Automatic quick stop of the cycle

To quick stop:

- Depending on how the cycle is set, the cycle stops automatically or the cycle stops until the user presses **Start**.
- The Finished Cycle indicator lights up red after the cycle is finished.
- Acknowledge the alarm by pressing **More** and then **Ack**.



- If the unit is equipped with a printer, the alarm text is also printed out as part of the cycle log.

Call a technician.

In case of a serious fault, always call a technician.

After the technician activates the key switch to the *Stepping/Authorized user* setting, the technician has the following alternatives:

- Restart the cycle where it stopped.
- Move the cycle to another phase and start the cycle from there or move it to the end.

To restart:

- Press **Start**.



To move to a different step:

- Press **More** and then repeatedly press **Step**.



After the cycle ends:

- The Finished Cycle indicator lights up red after the cycle is finished.
- Acknowledge the alarm by pressing **More** and then **Ack**.
- If the unit is equipped with a printer, the alarm text is also printed out as part of the cycle log.



For safety reasons, it is not possible to step past a pressure equalisation phase or a cooling phase.

Shutting off the alarm indicator - Avanti.

- Finish the current cycle.

- Press **More**.



- Press **Ack.** to acknowledge the alarm, by which the Alarm indicator goes out and the red background disappears.

To reset certain types of faults, a technician must first activate the key switch for *Stepping / Authorized users*.

Repeated alarms

If the process repeatedly hangs at the same alarm point, call a technician to step the process to the end. If several faults occur, only the last one is displayed.



**In certain phases, sensor faults prevent stepping of the program.
Stepping may only be done by trained personnel.**

Alarm printout in process documentation

Where a main fault causes one or more secondary faults, the operator panel shows on the most recent fault. If the unit has a printer or similar, all faults are printed out, together with the time when they occurred.

Doors

When a fault has occurred, the unloading door of a double-ended sterilizer will not open. Exceptions are errors that occur so late in the process that unlocking of the door has begun.

The door can only be opened when the correct password has been entered. For further information, see the menu description in the *Control unit* chapter.

Steam generator alarms

Alarms from the steam generator may be due to the operating pressure being exceeded or the water level in the steam generator falling below the minimum. Low water level may also indicate that the boiler water quality is beginning to be very poor and that the water should therefore be emptied.

Call a service technician to analyse and correct the fault, with the aid of the description in the *Advice and instructions* chapter in the TECHNICAL MANUAL.

	<p>NOTE! Important where a steam generator safety valve has been blowing off for a long time and the chamber is under pressure at the same time. Only switch off the sterilizer control switch as a last resort, because doing so disables certain safety functions. Instead, call a service technician who can trip the steam generator circuit-breakers.</p>
---	---

Error codes

The error messages listed below are defined in the control system. If more than one error occurs consecutively, only the error code for the last error is displayed.

If the sterilizer is equipped with a printer, the error message is printed out. For secondary errors, all error messages are printed out.

Information about the last twenty faults is saved in the control system and is accessible in the service menu. If the sterilizer has a printer, this information can be printed out.

Service codes

When the word “SERVICE” appears on the display, service is required and must be carried out by a service technician. See below for explanations of the codes.

	<p>NOTE! No error has occurred. The sterilizer can still be used.</p>
---	--

Error code/ Message	Explanation
BATTERY ERROR	The backup battery of the control system is flat. Programs and stored parameters may have been lost.
AI FAIL- CHAMBER	Chamber temperature sensor defective.

Error code/ Message	Explanation
AI FAIL- JACKET	Jacket temperature sensor defective.
AI FAIL- PRESSURE	Pressure transducer defective.
AI FAIL-LOAD	Load temperature sensor defective. NOTE: Not present on all sterilizers.
AI FAIL- DEGASS.	De-aeration temperature sensor defective. NOTE: Not present on all sterilizers.



Mistakes when correcting the above types of faults may lead to situations where there is a risk of injury. Always call a trained service technician.

Error code	Explanation
High pressure	The chamber pressure has been too high during the sterile phase. This may indicate the presence of air or non-condensable gases. The actual pressure in the chamber is compared to a theoretical saturation pressure calculated from the sterile temperature + 3°C. A message is printed in the alarm log when the error occurs.
Low pressure	The chamber pressure has been too low during the sterile phase. This may indicate a faulty or improperly calibrated sensor. The actual pressure in the chamber is compared with a theoretical saturation pressure calculated from the sterile temperature. A message is printed in the alarm log when the error occurs.
HIGH JACKET TEMP	The jacket temperature has been too high during part of the process.
GASKET FAILURE	Door gasket pressure too low.
DOOR FAILURE	Door(s) not closed and interlocked.
PUMP FAILURE	Vacuum pump has stopped.
HIGH TEMPER- ATURE	The chamber temperature has been above the permitted limit during the sterilization phase.

<u>Error code</u>	<u>Explanation</u>
LOW TEMPERATURE	The chamber temperature has been below the permitted limit during the sterilization phase.
PHASE TIME-OUT	The phase named on the display exceeded the time limits for completion. Check whether the cause is a component fault or media fault.
POST. TIMEOUT	The post-treatment exceeded the times limits for completion. Check whether the cause is a component fault or media fault.
MAINTENANCE	This message appears when the programmed service interval has elapsed and the current process is complete. The message continues to be displayed until it is de-activated by the service technician. The autoclave can still be used. Call a service engineer immediately.
MANUAL OUTPUTS	A digital output has been manually switched off or on. Call a service technician to reset the output to auto mode.
LEAK RATE FAIL	An automatic leak test has failed.
SUPERVISOR ERROR	The Supervisor's independent monitoring of process time and temperature conditions has indicated that these have not been fulfilled and have triggered an alarm.
POWER FAILURE	There has been a power failure longer than 10 seconds.
EMERGENCY STOP	The program has been stopped with the emergency stop button.
STEAM GENERATOR	The supply of feedwater to the steam generator has stopped working.
DOOR INTER-LOCK	The independent safety interlocking of media admission to the chamber, as controlled by the door switch, is faulty.
GASKET INTER-LOCK	The independent safety interlocking of media admission to the chamber, as controlled by the gasket pressure switch, is faulty.
PRESS. INTER-LOCK	The independent safety interlocking of the door function, as controlled by the chamber pressure switch, pressure monitor or the Supervisor, is faulty.

Error code	Explanation
TEMP. INTER-LOCK	The independent safety interlocking of the door function, as controlled by the load temperature switch, or the Supervisor, is faulty. NOTE: Not present on all sterilizers.
I/O FAULT	The control system has lost communication with the input or output cards. Call a service engineer immediately.
WATER SUPPLY	The water level in the tank is too low.
COMPR.AIR SUPPLY	Pressure of incoming compressed air is too low.
DEGAS. TANK FAIL	The temperature in the degassing tank has fallen below the permitted value. NOTE: Not present on all sterilizers.

General advice when using the sterilizer

- Keep the sterilizer door closed when the unit is not in use.
- Read the section “*General advice on packaging material*” in the guide below.
- If it is difficult to get items dry, the post-treatment stage can be modified. See the guide “*Cycle modification according to the type of load*” further down.
- Read the manual for the medical device to be sterilized before starting the process.
- Be alert to everything that appears unusual such as leaks, humming solenoid valves, stickily mechanical devices etc. Remedy the situation before it becomes a malfunction.

Heating of load

Heating of items to be processed may jeopardize sterilization result due to poor humidification. Make sure appropriate process has been chosen before loading the sterilizer.

Fire hazard

There have been reports of textile loads catching fire in the sterilizer chamber. In all cases this has been due to the load becoming excessively dry and hot. This can happen in two ways:

- The load has been placed in a heated chamber and left for a long time without the process being started. Ignition is believed to take place when the load is moistened again on the admission of steam to the chamber.
- The load is left in the chamber for a long time without the process being completed. This probably happens when the process has been interrupted because of a fault and the load has not been taken out of the chamber.
Ignition takes place when the process is completed and the load is exposed to air.

Users should be aware of the risks and establish procedures to ensure that loads are not left in a heated chamber for longer than necessary.

Weekly cleaning - Avanti

External cleaning.

Clean stainless steel surfaces on the outside of the sterilizer with a standard household cleaner that does not contain abrasives. Take care when cleaning painted surfaces, texts, and plastic parts.

Cleaning the chamber

When cleaning inside the chamber, a key switch on the front can be used to block the door open, and shut off chamber preheating at the same time.

On double-ended sterilizers, the same key switch can also be used to open and block the unloading door for better access; see below.

- With the sterilizer is in standby mode, turn the key switch to the locked position and remove the key. The text “DOOR KEY SWITCH” appears on the operator panel display.
- Open the door by pressing the **Open** button. Let the sterilizer cool down before starting work.





The sterilizer should have cooled down before cleaning. When the key switch cannot be constantly observed, the person doing the cleaning must always take the key with them. This is to ensure that no-one mistakenly resets the key switch.

- Clean the strainer in the chamber floor drain.
- Remove any shelves, guides, and bottom plates and clean the inside of the sterilizer chamber. Use a general-purpose chlorine-free cleaner. Scouring powder may be used occasionally on stubborn stains. **Never use steel wool.** Sterilizers that are often used to sterilize products containing salt require especially thorough cleaning, since residual deposits may even have a corrosive affect on stainless steel. An acidic cleaning agent followed by careful rinsing is most suitable for the purpose.
- After cleaning, insert the key in the key switch and turn it to the initial position.



- Then close the door by pressing the **Close** button.



- On double-ended sterilizers, the unloading door can be opened for cleaning by repeating steps in the points above.

Note! Note that there may be restrictions on door opening on SPF sterilizers and sterilizers with controlled work flow.

- When cleaning is complete, both doors must be closed and the key must be left in the key switch.

Bowie Dick testing

The purpose of the Bowie Dick test is to reveal deficiencies in the ability of the sterilizer to expel air and reveal leaks or an excessive content of non-condensable gases in the steam. In testing in accordance with EN 285, (or applicable national standard) an indicator paper is placed in the centre of a test pack. The pack, which must be 220 - 300 mm square and approx. 250 mm high, must consist of folded cloths of 100% cotton. The pre-treatment of the test programme must be identical to the pre-treatment for the processes used for routine sterilization, while the steriliza-

tion time may be adapted to the performance of the sterilizer but must not exceed 3.5 minutes.

When the indicator paper has been sufficiently exposed to steam at a particular temperature, further exposure tends to hide the indication of any deficiencies. GETINGE's Bowie Dick programme is therefore tested with the shortest possible sterilization time so that any deficiencies are not concealed by overexposure.

In day-to-day work, the above, standardised test packs for the sake of convenience are sometimes replaced by various types of disposable packs which are manufactured by a large number of manufacturers. As these packs are generally even more sensitive to overexposure than the standardised test pack, it is extremely important to choose the correct make. Test packs in accordance with BS 7720:1995 must be used for GETINGE's Bowie Dick programme.

Approved consumables

Consumables are used for different purposes as packaging for goods to be sterilized, for testing, for replacement of sterilizer parts with limited life or a sterilization media for low-temperature sterilizing. The list of consumables below is intended as a guide to be used with GETINGE's CE-marked sterilizers.



Always check whether consumables have a use-by date before using them.

Articles for packing items to be sterilized

Packaging materials must be matched to the method of sterilizing, the load carrier and the goods to be sterilized. To guarantee compatibility with GETINGE sterilizers, it is the responsibility of the user to ensure that packaging material and methods used conform to European standard EN868-1, the other parts of which also specify particular requirements for different types of packaging material.

Packaging material for steam sterilization

Getinge AB recommends warping in paper for textile packages and for instrument grilles in baskets and containers.

Getinge AB recommends paper/plastic bags for separately packed articles.

Packaging material for formaldehyde

For formaldehyde sterilizing, we recommend paper/plastic bags intended for steam sterilizing.

Articles for test purposes

The user is responsible for maintaining a routine check of the operation of the sterilizer in accordance with European standard EN17665. There are various types of test articles on the market to assist the user.

Chemical indicators

Chemical indicators used when testing various types of sterilizer must conform to European standard EN867-1, the other parts of which also specify particular requirements for different types of indicator.

Getinge AB recommends using chemical indicators in steam sterilization processes. For other types of processes it the user's responsibility to evaluate whether individual makes are applicable to the GETINGE sterilizer process.

An established test method in which chemical indicators are used is the Bowie-Dick test, with test packages or its equivalent with a disposable package. For information see also under "Bowie-Dick testing".

Biological indicators

Biological indicators used when testing various types of sterilizer must conform to European standard EN866-1, the other parts of which also specify particular requirements for different types of indicator.

Getinge AB recommends using biological indicators in steam sterilization processes. For other types of processes it the user's responsibility to evaluate whether individual makes are applicable to the GETINGE sterilizer process.

Sterilizer parts for periodic replacement

Spare parts

So that correct operation and product safety can be guaranteed, parts for recorders, printers or periodic maintenance must be genuine GETINGE spare parts or parts approved by Getinge Infection Control. Article numbers of genuine parts are stated in the relevant sections of the service manual.

Sterilization media for low-temperature sterilising with formaldehyde sterilizers

Low-temperature sterilizing can only be done with special sterilizers intended for the purpose. During sterilizing with formaldehyde, the medium is added from containers attached to the sterilizer.

Formaldehyde solution

Containers holding formaldehyde solution are brought to the site and attached to the sterilizer by the operator.

Where relevant, details of concentration, volume, packaging, handling and properties are described under *Operating instructions* and under “General advice on formaldehyde sterilizers”.

Accessories

The sterilizer's CE label makes the manufacturer responsible for ensuring that its product safety and function satisfies the strict requirements laid out in the relevant EC directive. Accessories that are mechanically, electrically or otherwise connected to the sterilizer must be compatible with this. As a result, only equipment that has been evaluated by Getinge AB and registered as approved equipment may be used together with the sterilizer.



Should non-approved equipment be used, Getinge AB exempts itself of all product liability for the sterilizer and its CE label.

Approved accessories

The accessories listed below are compatible with the sterilizer once the sterilizer has been configured to function with the accessory in question. Such configuration shall be performed by a professional authorized by Getinge Sterilization AB.

		HS44	HS55	HS66	HS69	HS Floor Loaded
Accessories for extended documentation, etc.						
1	A4-Printer EPSON LX-300	X	X	X	X	X
2	A4-Printer LEXMARK	X	X	X	X	X
Loading equipment accessories						
3	Shelf Rack (Light load)			X	X	X
4	Shelf (light load)			X	X	
5	Shelf Rack (heavy load)			X	X	X
6	Shelf (heavy load)			X	X	
7	Rails for Shelf Rack			X	X	
8	Rails for Baskets			X	X	

9	Rails for AGS	X	X	
10	Support bar (Rails for basket)	X	X	
11	Loading Platform	X	X	
12	Loading Module	X	X	
13	L-Rails (Extendable Shelves)	X	X	
14	Extendable Shelves (perfo)	X	X	
15	Extendable Shelves (Wire)	X	X	
16	Sterilizer Basket (DIN) (600*300*150/290)	X	X	
17	600*400*115/150/290)	X	X	
18	Sterilizer Basket (ISO) (100) / (200)	X	X	
19	Sterilizer Basket (SPRI) (100) / (200)	X	X	
20	Sterilizer Basket (SPRI- Swedish) (100) / (200)	X	X	
21	Automatic Loader (Basket)	X	X	
22	Automatic Unloader (Basket)	X	X	
23	Automatic Loader (Racks)	X	X	
24	Automatic Unloader (Racks)	X	X	
25	Basket Feeder (Manual)	X	X	
26	Loading Trolley Fix Height	X	X	X
27	Loading Trolley Height Adj. (Racks)	X		
28	LT FIXED 6606/6613HL/ 633-07	X		
29	LT FIXED 6610/6620HL/ 633-10	X		
30	LT FIXED FOR 6613/633- 13	X		
31	LT FIXED FOR 6617	X		
32	LT FIXED SAL FOR 6610/ 633-10	X		
33	LT FIXED SAL FOR 6613/ 633-13	X		

34	LT FIXED SAL PD 6610/ 633-10			X		
35	LT FIXED SAL PD 6613/ 633-13			X		
36	LT H/A 6610/6620HL/6910/ 633-10			X	X	
37	LT H/A FOR 6613/6913/ 633-13			X	X	
38	LT H/A FOR 6617			X		
39	LT H/A SAL 6x10/633-10			X		
40	LT H/A SAL 6613/6913/ 633-13			X	X	
41	LT H/A SAL PD 6x10/633- 10			X		
42	LT H/A SAL PD 6x13/633- 13			X		
Other accessories.						
43	Air Compressor 175 EO-24			X	X	
44	Air Compressor 55E-24			X	X	
45	Water Treatment System "RO 51"			X	X	
46	Water Softener Princess MIDI			X	X	
47	Water Softener Princess TURBO			X	X	
48	Water Chiller MINI		X	X	X	
49	Water Chiller MIDI		X	X	X	
50	Water Chiller MAXI		X	X	X	
51	AGS			X	X	
52	NetCOM	X	X	X	X	X
53	Free standing steam generator		X	X	X	

OPERATION INSTRUCTIONS



The following operating instruction deals with the day-to-day use of the sterilizer.

A further copy of this operating instruction, together with the program combination, is packaged with the sterilizer when it is dispatched from the factory.

These documents must be displayed so that the personnel can read them when working at the operator panel.

Use



This sterilizer must not be used for processing other material than stated in the program combination list.

Pathogenic material must not be sterilized in this sterilizer.



Warning! Fire hazard!

Do not leave goods in a heated chamber. See chapter *Operation*.



Beware of hot surfaces inside the sterilizer chamber when the door is open!



Keep the sterilizer doors closed as much as possible to reduce energy loss and minimise temperature rise in the room.

Daily preparations

- Learn the functions of the control buttons and signal lamps by studying the *Instruments* and *Control unit* chapters. Find out how the user-programmable parameters are set on this unit.
- Open valves for water, air and, where applicable, steam.
- Switch on the mains switch of the unit.
- Check that recording instruments and printers have sufficient paper. The paper of recording instrument shows a red line when it is nearly finished.
- Run the first steam sterilization process of the day with the chamber empty. This heats up and drains the system pipework.

Running a process

- Select the desired program. The selected program is indicated on the control panel.

Parameter password

- Before a selectable parameter can be changed, a parameter password must be entered, after which all parameters (see Program combination) can be changed.

Password-protected programs

- Programs that are not intended to be used routinely are protected with a password. Some degree of consideration is called for before a password-protected programs is chosen. Examples include test programs, programs for emergency situations, programs with selectable parameters or programs using some sterilization medium other than steam.
- Load the sterilizer.

Start via operator panel Avanti

- Make sure that cycle media are available.
- Close the door by pressing **Close**.
- If the “Door locked” indicator is lit and the **Start** button can be selected, the machine is ready to start.





If the lamp does not light up, start is prevented for some reason (also see chapter *Operation and Control unit*).

- Choose the cycle by pressing the **Cycles** button in the button field.



In order to run the latest cycle, this step can be skipped.

- Press **Start** to start the cycle.



After completion of the process



Beware of hot surfaces inside the sterilizer chamber when door is open!

The control panel displays progress of the process.

Operating from the operator panel Avanti

- The “Finished cycle” indicator lights up green after an error-free cycle is completed.



- The panel lights up green and an acknowledgement key lights up on the completion of an error-free process. (Does not apply to automatic loaders)



- Press **Open** if the door on the discharge side does not open automatically.



Process check

Check that the completed process has been carried out correctly by comparing the process printout with a corresponding type load printout from the sterilizer validation.

Goods handling

Remember that the goods may contain a considerable amount of heat when unloaded. Position them with regard to a good working environment.



Note that the goods may be very hot immediately after unloading.

Let the goods cool down or wear safety gloves to handle them.

Long sterilizers can take two load carriers in a row. Use a hook (ordered separately) to reach into the chamber and extract the inner load carrier.

Things to do when the work is finished

Unless otherwise prescribed by local rules:

- Turn off the control power supply by the switch on the front.
- Inspect the strainer in the bottom of the chamber and clean it if necessary.
- Close valves for air, water and, if used, steam and gas.

If necessary:



- Shut down the sterilizer for long enough to let it cool down, eg overnight.
- Clean the inside of the chamber. Use a chlorine-free cleaner if necessary.



The sterilizer must always be cold when cleaned. To prevent injury, switch off the power to the control system.

The cleaning instruction is given in the section “General advice on using the sterilizer” in the *Operation* chapter.

To interpret the “Finished cycle” indicator

	<p>Normal routine cycle: After completion of fault-free normal routine cycle, the indicator shows a steady green light.</p>
	<p>Maintenance cycles: After a completed, fault-free automatic leakage test or filter sterilization, for example, the indicator shows a flashing green light.</p>
	<p>Normal routine program: On the completion of an error-free routine process, the panel lights up green and an acknowledgement key lights up. (Does not apply to automatic loaders)</p>
	<p>Normal routine cycle with fault: After completion of stepped or alarmed normal routine cycle, the indicator shows a steady red light.</p>
	<p>Maintenance cycles with fault: After completion of a stepped or alarmed maintenance cycle the indicator shows a flashing red light.</p>

Stopping the program or a blowing safety valve

In an emergency, the program can be stopped or a safety valve that is blowing off can be made to close, by means of the EMERGENCY STOP button on the front panel, without disabling the safety systems of the unit. An alarm is triggered when the program is stopped.

- Press the EMERGENCY STOP button.
- Follow the instructions under “What to do if there is an alarm” below.



Only switch off the control unit power switch as a last resort, since this affects the safety systems of the installation.

The main power supply switch or disconnecter to the sterilizer may be turned off only in an emergency.



On power failure or if the control switch or working switch of the sterilizer had to be turned off during a process, there is a risk of leakage at the door. Safety measure when there is positive pressure in the chamber:

KEEP WELL AWAY FROM THE DOOR AND CALL A TECHNICIAN!



ALWAYS LEAVE THE PREMISES and call a technician if the chamber pressure is in the RED area of the pressure gauge.

Measures in case of alarm

Programs that are installed to be ended automatically

- The program ends automatically.

An emergency stopped process or program that did not finish automatically.

- Note the process phase during which the fault occurred.
- Silence the alarm signal by pressing **Silence alarm signal**.



Options for alternative actions are described in the chapter “Alarm” in chapter *Operation*.

After a fault in a process, the password must be entered before the loading side door can be opened.

CONTROL UNIT PACS 3500

The letters **PACS** stand for **P**rogrammable **A**utoclave **C**ontrol **S**ystem.

The purpose of the control system is to issue orders and send them to the executive components of the unit so that a number of process steps are performed in accordance with a predetermined template. The order signals are worked out by the computer program of the control unit in conjunction with measurements of actual parameter values for the current program. These are usually times, temperatures and pressures.

Several different pieces of equipment can be connected to the control unit for programming, monitoring and documenting the processes.

The operator communicates with the control unit via a control panel or an ordinary PC. There are several versions of the operator-machine interface, from the simplest, which consists of two pushbuttons and eight LEDs to show that certain statuses have been reached, to the most advanced, which allows complete programming of the control system, among other things.

All operator panels are manufactured to monitor the processes by displaying all the set parameter values as well as actual values on request. All relevant data associated with a given process, such as cycle number, operator number, date, etc., can be entered by the operator.

Programs, system definitions and process data can be documented by connecting a printer to the unit. A host computer can also be connected directly to the CPU of the control system.

If necessary, a measurement and monitoring system which is completely independent of the control system, can be set up by providing the equipment with a SUPERVISOR. This contains a separate CPU and its own measurement and control boards. The SUPERVISOR performs its measurements by means of separate temperature and pressure sensors alongside those of the control unit. The system has links to the control unit CPU and can therefore use the shared operator panel, as well as adding the control unit readings to the process documentation. The SUPERVISOR can also be involved in independent interlocking of door opening, for example.

The computer contains programs for automatic calibration of the temperature and pressure sensors. Where alternative correction constants are known, they can be entered manually. The testing functions include means of activating analog and digital outputs and for monitoring analog and digital inputs.

The control unit hardware is divided, so that the operator panels can form small separate units that are easy to position at the most suitable location. CPU, measurement and control boards and the power supply are installed in separate electrical enclosures which are connected to the operator panels by shielded cables.

A number of special terms

STERILIZATION refers to the entire series of treatments that make up a process aimed at achieving the total killing of all living organisms. This applies to sterilizers and usually includes air removal, heat treatment and a drying phase.

STERILIZING refers to the actual killing part of the process, the heat treatment.

On the same basis as the two terms above, **STERILIZATION TIME** refers to the duration of the entire process from the start until the objects can be taken out of the sterilizer. The **PROCESS TIME** is the same as the sterilization time.

The **STERILIZING TIME** is only that part of the process for which the programmed **STERILIZING TEMPERATURE** exists in the chamber.

In this context, **PARAMETERS** means **FACTORS THAT INFLUENCE THE** sterilization process. Examples of parameters in the sterilization process are temperature, pressure, time, humidity, gas concentration, etc.

PARAMETER VALUES may be permanently set in the program, be adjusted by the operator, be included in selectable recipes or downloaded from a higher-level system.

Control panel type Avanti

General description

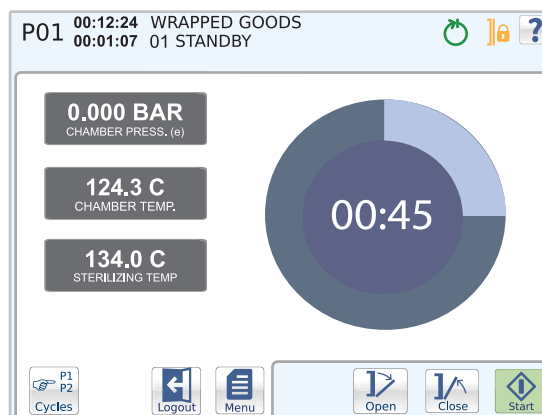

Screen

The screen can be divided into three areas: status field, middle field and button field.

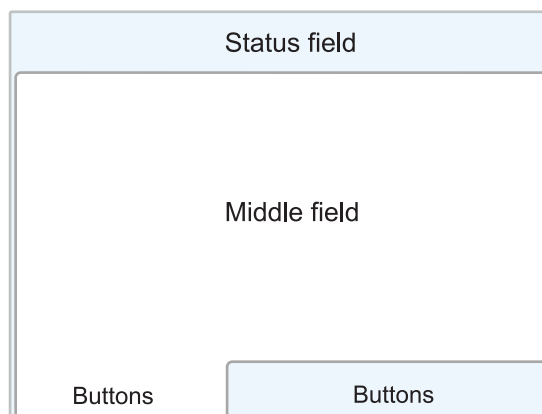

Status field

The status field is displayed in all cycle images. The field contains information about the machine's current status, such as the current cycle and phase and the time these have lasted. The message is displayed in a blue box to the left of the indicators.

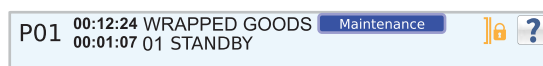

In the event of an alarm, the status field color changes to red and an error message displays in a red message box to the left of the indicators.



Middle field







The middle field is specific for the screen and displays unique functions and information for the respective menus; see the section Screens in the Main Menu chapter.















Button field









The button field shows the application buttons that are used to give commands.



Buttons and symbols





Symbol		Operation	Description
Indicators		Doors locked	The machine's doors are closed and locked.
		Doors closed	The doors of the machine are closed.
		Cycle in progress	The machine is processing the selected cycle.
		Completed cycle	Steady light: Normal cycle concluded without warnings or errors.
			Flashing light: Test cycle concluded without warnings or errors.
		Completed cycle	Steady light: Cycle concluded, but a warning and/or error has arisen during processing.
			Flashing light: Test cycle concluded, but a warning and/or error has arisen during processing.
	Alarm	Solid light until the process reaches "Stand by". Only then can the alarm be acknowledged by pressing a button.	

Buttons		Help	No function. For information, see "User Manual" or "Service manual."
		Cycles	Open menu to select cycle. Note: Not displayed on the unloading side.
		Home	Display latest start screen.
		Back	Return to the previous window or menu, or undo the input.
		Alarm	Display menu for alarm history.
		Login	Display login screen.
		Logout	Log out current user.
		Menu	Return to the main menu.
		Save	Save edited data.
		Calibrate	Execute calibration.
		Submit	Submit values to the PACS.
		Print	Send selected data to the printer.
		Start	Start the selected cycle. Note: Not displayed on the unloading side.
		Open	Open machine door.

		Close	Close machine door.
		More	Optional when alarms or preprogrammed functions are active.
Alarm-handling		Silence alarm signal	Switch alarm signal off.
Information		Cycle information	Provides information about current process and phase, as well as the time these have been going on for. The information is displayed on the top left.
		Messages	Displayed if an incident occurs. The message is displayed in a blue text box on the left of the indicators.
Other points		Save	Save changes and inputted values.
		Numeric keyboard	Shift from alphabetic to numeric keyboard.
		Alphabetic keyboard	Shift from alphabetic to numeric keyboard.
		Right and left arrow	Move the cursor in the input window.
		Zoom in/out	Enlarge/reduce plot graph.
		Insufficient user access	No authorization for accessing the menu.

		<p>Scroll list</p>	<p>If there are more rows than space available on the screen, a scroll list is displayed on the right. To reach the row above or below, just drag the button.</p>
--	---	--------------------	---

The various states of the buttons

	<p>Active</p>	<p>The button can be pressed</p>
	<p>Pressed</p>	<p>The button is pressed.</p>
	<p>Not available</p>	<p>If the symbol remains, the button is currently not available.</p>
	<p>Ready to start</p>	<p>The cycle can be started.</p>

Boot screen

When the panel starts, the screen below displays. The blue bar moves from left to right. When the panel is ready and the control system is ready, the panel automatically switches to the pie chart screen.

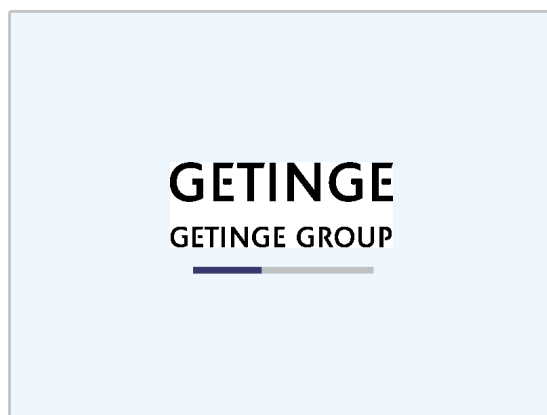

In case of communication errors between the panel and the operating system, the blue bar travels back and forth. There is no communication with the operating system as long as this screen displays and no command can be sent to the operating system.

Call a service technician.

Pop-up windows and dialogue windows

Alarm pop-ups

Shown below is an example of an alarm pop-up.

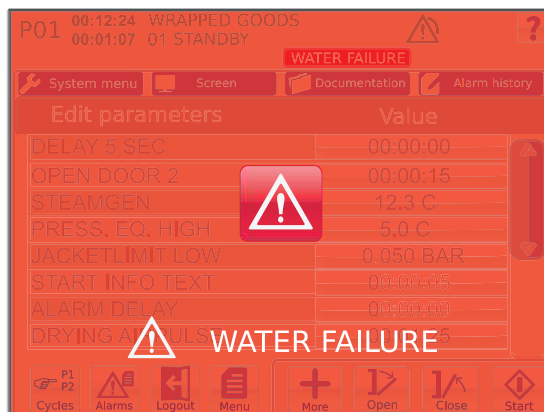

In the event of an alarm, the current alarm displays as a pop-up window on the screen and an alarm sounds. For alarm management, see the "Alarm" section in the chapter *Operation* of the USER MANUAL.

Information pop-ups

Displayed below is an example of an information pop-up.

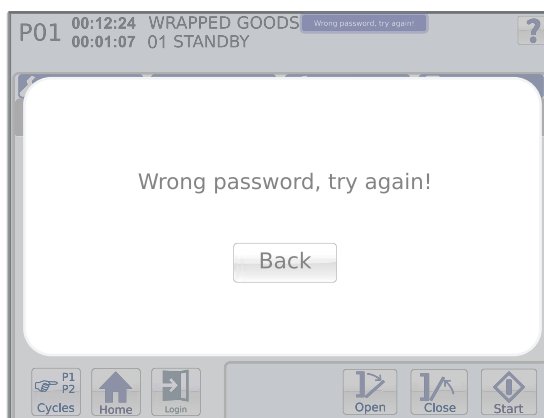

The information is displayed on the screen. Press the button to return to the previous procedure screen.

Dialogue window

Shown below is an example of a dialogue pop-up.

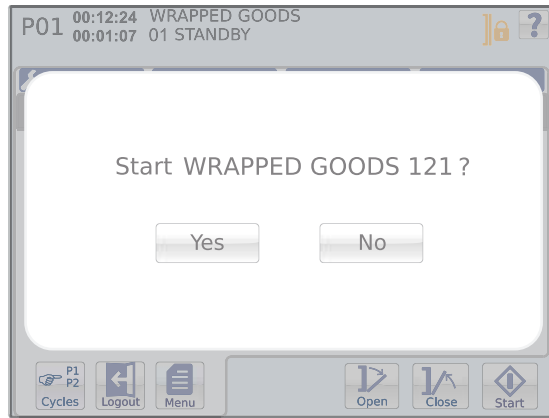

The window remains on the screen until a selection is made by pressing the desired button.

Green information window

The window and an acknowledgement button lights up to signal that the process is ready.

An audible signal sounds.



The window remains on the screen until the acknowledgement button is pressed or the door is opened automatically.

Inputting window

Here are two examples of inputting windows.

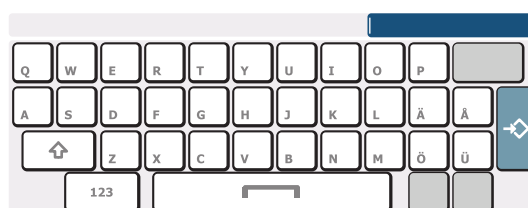

To enter a name, press the desired letters.

To toggle between small and capital letters, click the arrow up button down to the left.

To switch to a numeric keyboard, press the button with numbers at the bottom left.

Press **Save** furthest to the right to save the entry.



To edit the time, mark the number you wish to edit using the arrow keys at the bottom. Press the desired number. To save the entry, press **Save** at the bottom right.

Different inputting windows exist depending on the input data required.

Operator menu Avanti

Description of menus and functions

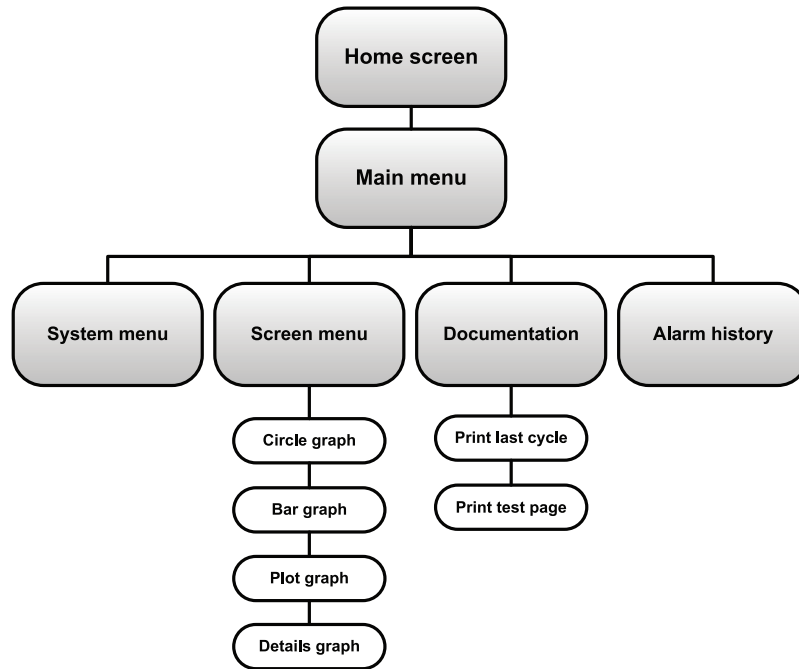

Start screen

The start screen allows access to the main functions for starting a cycle.



Open/Close door.

The door is opened and closed with the **Open** and **Close** buttons, respectively.

Cycle selection

Cycles are selected with the  button in the bottom left corner of the button field.

A list of optional cycles is shown.

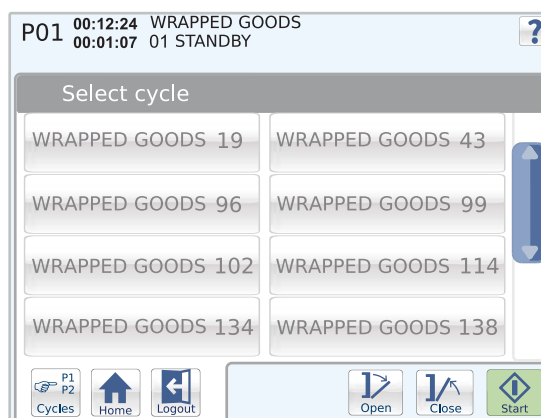

To select a cycle, press the desired cycle. The previous screen is displayed again.

The selected cycle is displayed in the top left corner of the status field.

Note!

The function is not available from the unloading side.

Start cycle

Selected cycles are started with the **Start** button. If the sterilizer is not ready to start, a message is shown.

Note!

The function is not available from the unloading side.

Various information about the current cycle is displayed depending on the current start screen. For further information, see the *Screens* section in *Main menu*.

The length of time that the cycle or current phase has been running is displayed in the status field. Also displayed here is the current cycle indicator.

Login/logout

- To log in, mark **Login**. An inputting window is displayed for inputting the password.
- Because a user is already logged in, the **Logout** button is displayed instead. This logs out the current user.
- Typing in an incorrect password brings up an information window. Press the **Back** button to return to the data entry window.
- If an incorrect password is entered on login when starting the cycle, the panel returns to the previous menu after one minute.

Main menu

The **Menu** button returns you to the main menu.

System menu

About

A list of machine specific data is displayed.

The following information is displayed:

- Machine name
- Application version
- Panel version
- PACS version
- PROM date
- Serial number
- Total amount of cycles

Other menus require a password and are described in the Service Manual.

Screens

Circle graph

The start screen shows a pie chart and three cycle parameters.

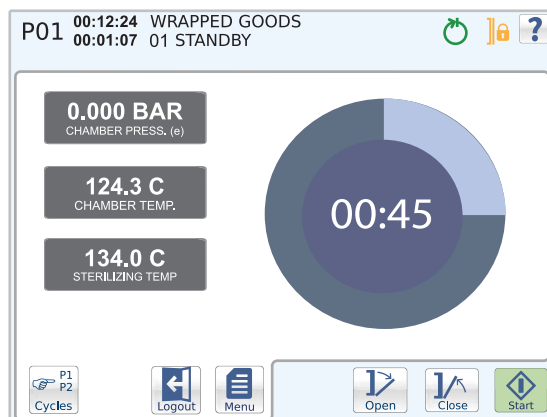

The pie chart graphically displays the time remaining for the cycle. The circle diagram also displays the time remaining in digit form.

The following cycle parameters are displayed:

- Current chamber pressure
- Current chamber temperature
- Sterilization temperature for the selected cycle

Bar graph

The start screen displays two cycle parameters, as well as a bar graph for the respective parameters and cycle time remaining.

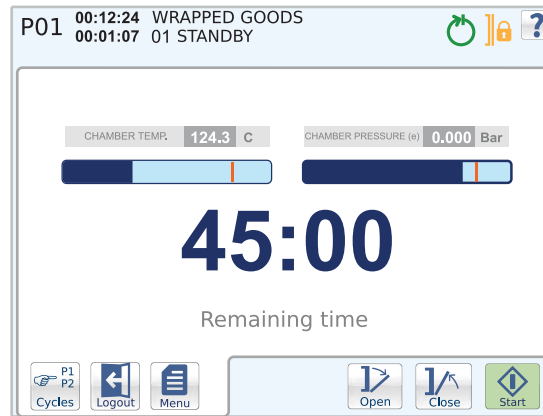

The following cycle parameters are displayed:

- Current chamber temperature
- Current chamber pressure

Plot graph

The start screen displays a plot graph with various cycle parameters. The status field also shows other cycle parameters. The remaining cycle time is displayed to the right in the status field.



The following cycle parameters are displayed in the status field:

- Current chamber pressure
- Current chamber temperature
- Sterilization temperature for the selected cycle

The following cycle parameters are displayed as graphs:

- Current chamber pressure
- Current chamber temperature
- Current jacket temperature

In order to enlarge the graph, press **Zoom in**. When the graph is enlarged it is possible to navigate by pressing somewhere on the screen and then dragging with a finger.

Details Graph

The start screen displays a list of parameters that shows information about the system and the current cycle. The remaining cycle time is displayed on the top right-hand side, above the list.

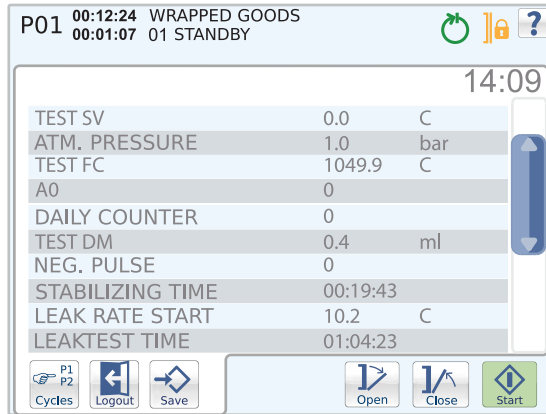

Documentation

An pull-down menu with optional printout modes is displayed. The possibility of choosing printouts varies depending on the user.

The following printout modes exist:

- Print last cycle, latest cycle run.
- Print alarm list, list of the most recent alarms. Password required.
- Print cycle
A list of optional print cycles is displayed. To print, select the print cycle of your choice and press **Printout**. Password required.
- Print test page
- Print all cycles. Password required.
- Print machine setup. Password required.

Note!

It is not possible to print during the current cycle.

Alarm history

A list of the last 20 alarms is displayed.

For more detailed information about an alarm, press the alarm you wish to select.

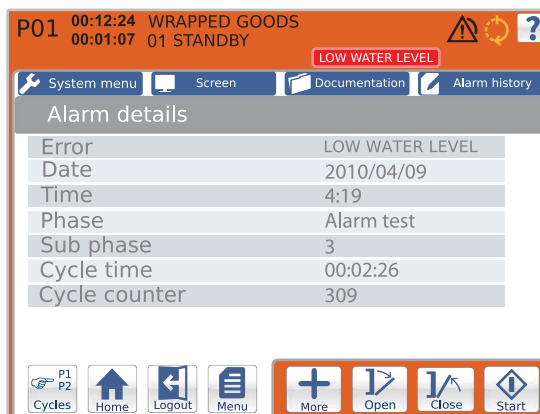

The following alarm information is displayed:

Error	Description of the alarm.
Date	The date when the alarm triggered.
Time	The time when the alarm triggered.
Phase	The phase that was current when the alarm triggered.
Sub-phase	The sub-phase that was current when the alarm triggered.
Cycle time	Specifies how long the cycle had been going on when the alarm triggered.
Reset counter	The number of cycles executed when the alarm triggered.



Liquids must not be processed with any of these programs.
Hazardous waste and explosive materials must not be processed in this sterilizer.



Door blocking key

The door does not close when the key is in the locked position and the door is in open position, as indicated by the symbol. When entering or cleaning the chamber the key must be removed from the locking device.

P 0 1 Wrapped goods, textiles, porous load

RAX2000

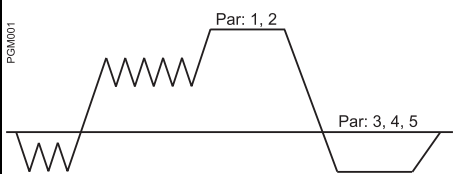

Parameter		Range	Delivered	Actual
Negative pulses	---	3	3
Positive pulses	---	5	5
1 Sterilizing temperature	°C	134	134
2 Sterilizing time	min	3 - 7	4
3 Postvacuum time	min	0 - 90	5
4 Postpuls steam	---	0 - 25	0
5 Postpuls air	---	0 - 25	0

P 0 2 Wrapped, heat sensitive material, rubber, plastic, porous load

RAX2001

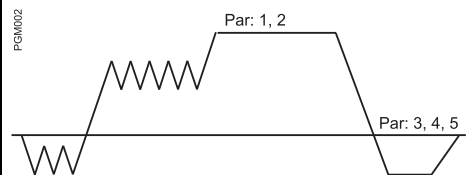

Parameter		Range	Delivered	Actual
Negative pulses	---	3	3
Positive pulses	---	5	5
1 Sterilizing temperature	°C	121	121
2 Sterilizing time	min	16 - 20	16
3 Postvacuum time	min	0 - 90	5
4 Postpuls steam	---	0 - 25	0
5 Postpuls air	---	0 - 25	0

P 0 3 Rapid process for single, open instrument

RAX2002

Password required!

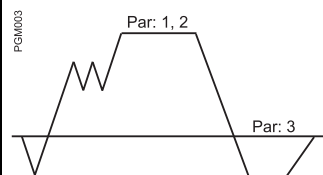

Parameter		Range	Delivered	Actual
Negative pulses	---	1	1
Positive pulses	---	2	2
1 Sterilizing temperature	°C	134	134
2 Sterilizing time	min	3 - 90	4
3 Postvacuum time	min	0 - 90	3

P 0 4 Bowie & Dick test						
RAX2003 <i>Password required!</i>						
PGM004		Parameter		Range	Delivered	Actual
		Negative pulses	---	3	3
		Positive pulses	---	5	5
		1 Sterilizing temperature	°C	121 - 135	134
	2 Sterilizing time	min	0 - 15	1	
	3 Postvacuum time	min	0 - 90	3	

P 0 5 Automatic leak rate test						
RAX2004 <i>Password required!</i>						
PGM005		Parameter		Range	Delivered	Actual
		1 Stabilizing time	min	10 - 90	10
		2 Test time	min	10	10

